



型号(1代码·2A)  
GAADBP70

■ 请按步骤①~②选择型号和参数后进行订购。



型号区分:  
代码 7 天发货



代码	类型	材质	表面处理/颜色
GAADBN	可折叠型	PA6	黑色

■ GAADBN 特点:  
● 控制设备、测量设备、集装箱的搬运移动。

GAADBN

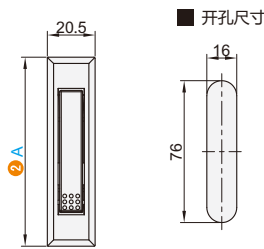
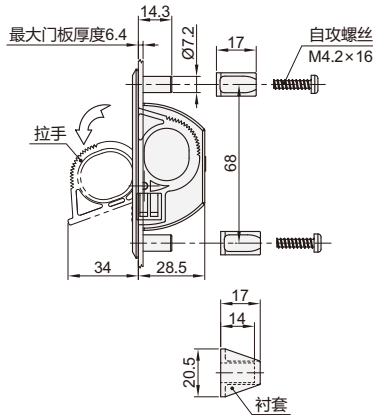

型号		参考重量 (kg/pcs)
1代码	2A	
GAADBN	81	0.05



代码	类型	抓手形状	材质	表面处理/颜色
GAADBO	带固定 垫片型	方形	PVC	透明
GAADBP			ABS+PC	黑色
GAADBQ				象牙色

GAADBO

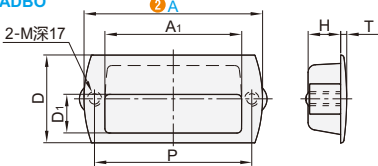

■ 固定件

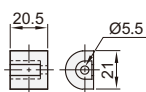

■ 开孔尺寸

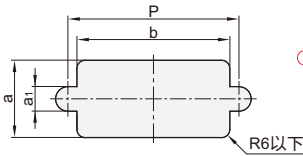

①注: 附配螺钉适用于安装侧板厚为1~5mm时, 超出该范围时, 请根据板厚, 自备螺纹长度10mm以上的螺钉。

GAADBP  
GAADBQ

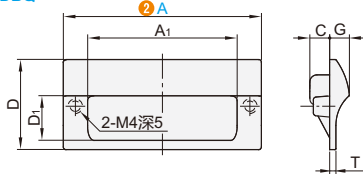

■ 开孔尺寸

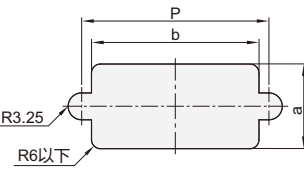

使用示例

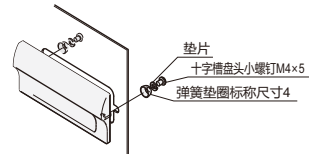

1代码	2A	A1	D	D1	C	G	H	M	T	开孔尺寸				适用门板厚度	参考重量 (kg/pcs)
										P	b	a	a1		
GAADBO	118	90	58	25.5	—	—	21.5	M4	4	104	95	48	11	1~11	0.04
	130	92	86	43.5	—	—	28	M5	5	110	99	71	12		0.10
GAADBP GAADBQ	70	43	38	17	9	10.5	—	—	3	58	48	25	—	0.5~3.2	0.02
	90	63	44	21.5	—	—	—	—	3	78	68	31	—		0.03
	110	83	50	24.4	11	11	—	—	3.5	96	90	36	—		0.04
	140	109	64	34	—	11.5	—	—	3.5	126	116	48	—		0.06



邮箱: Service@srdfaa.com



传真: 0755-8957-5523